

## Meteorite 15

design  
Pio & Tito Toso

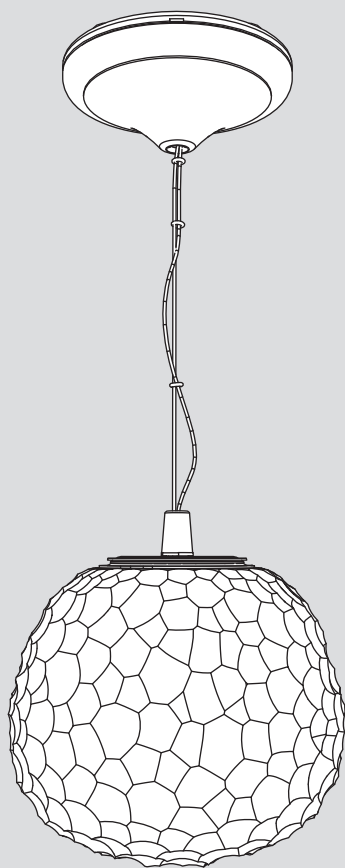



i

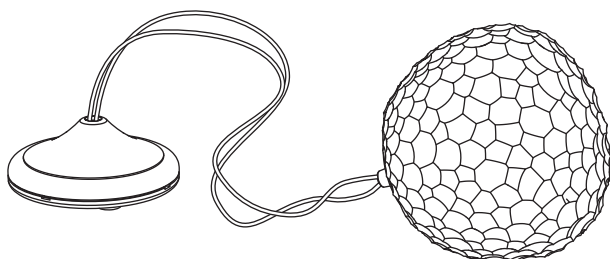
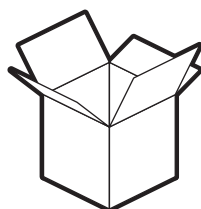
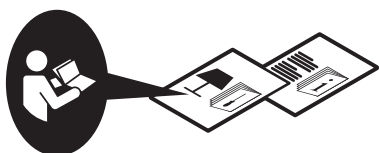
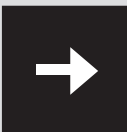
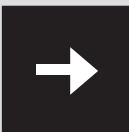
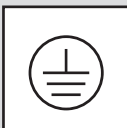

1

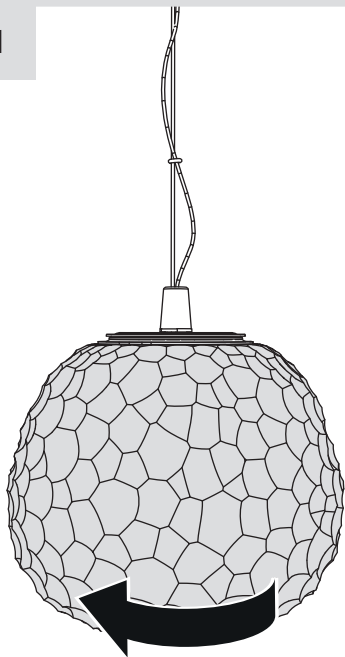

2

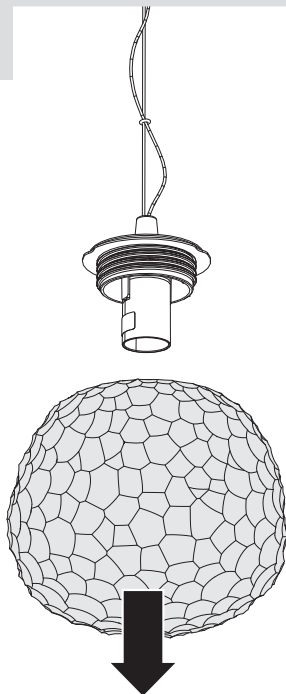

3

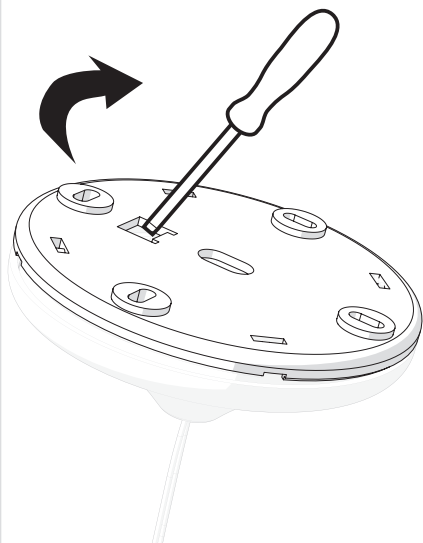

4

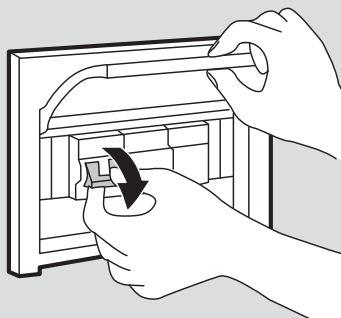
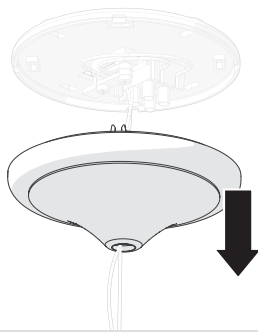

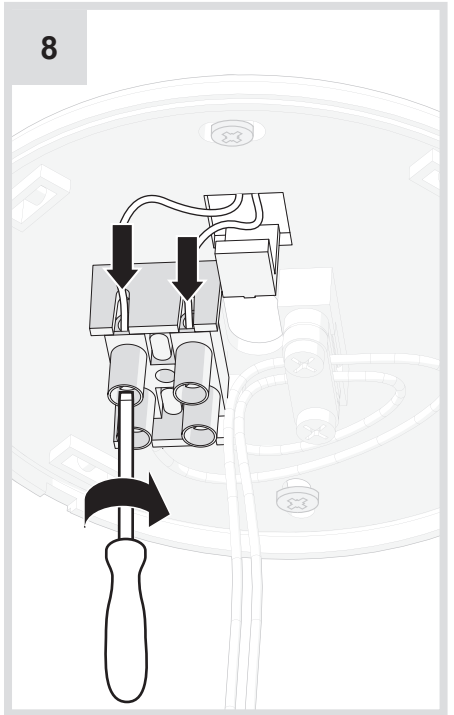
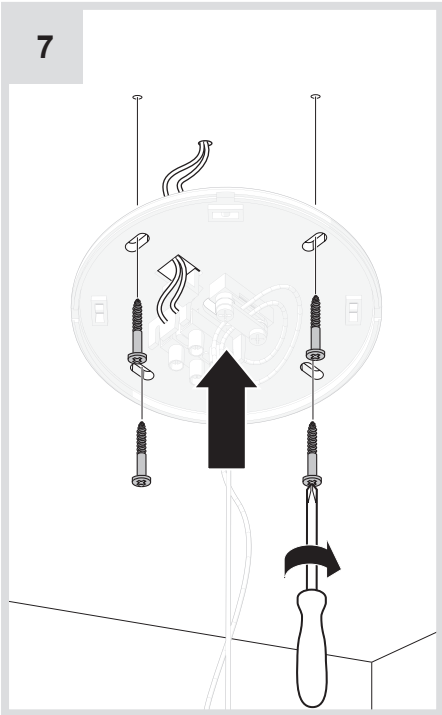
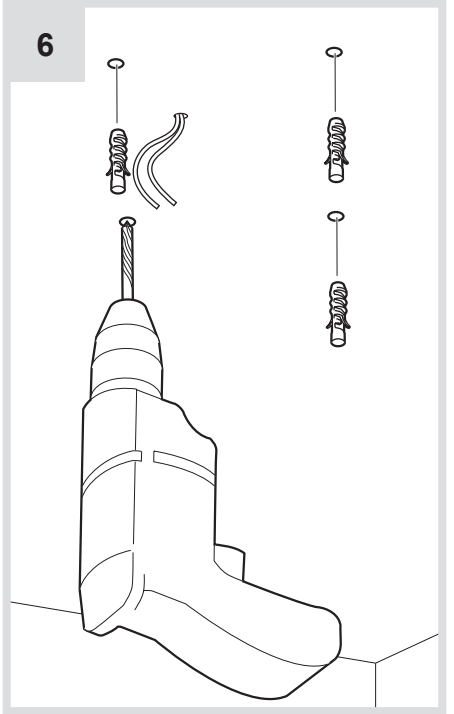
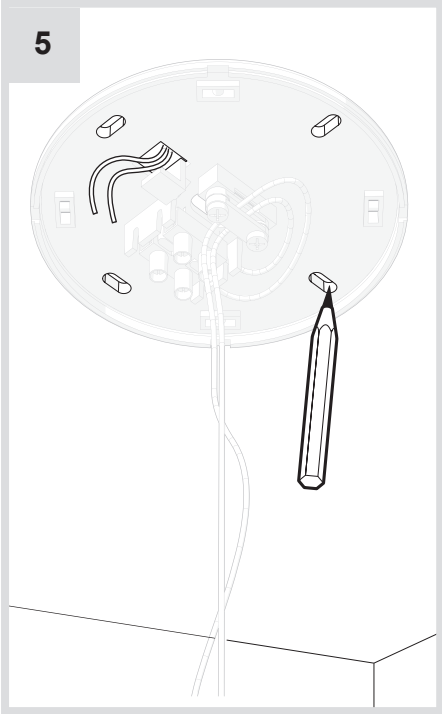

9

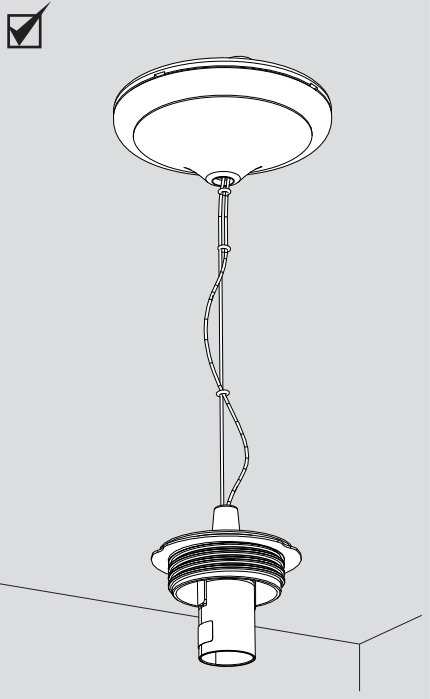
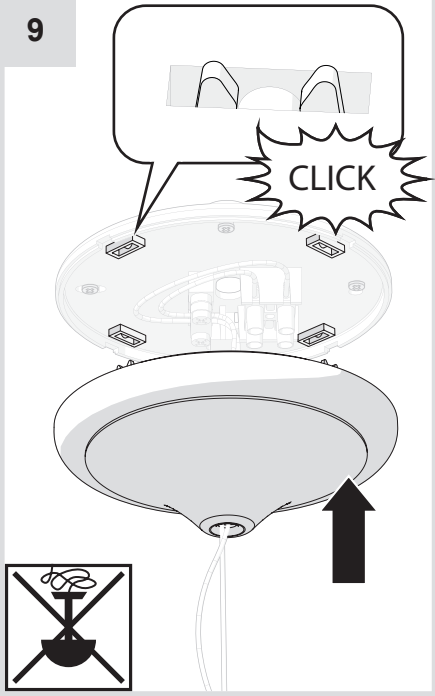

10



11

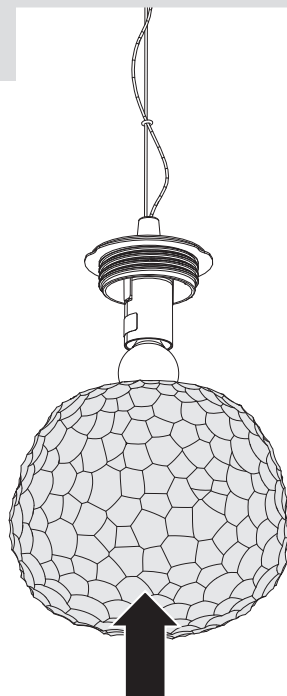

12

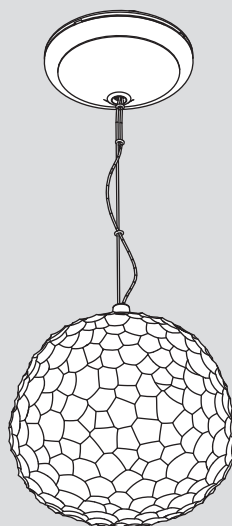
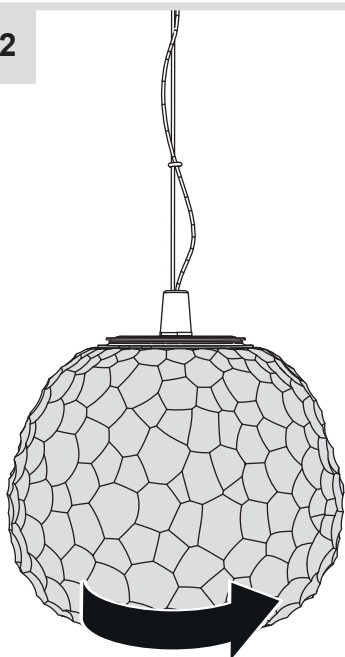

i



1

2

10

11

12

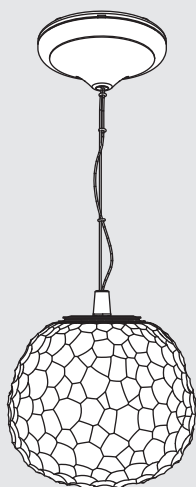

**MAX 4W LED E14**

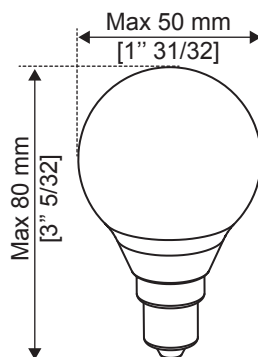

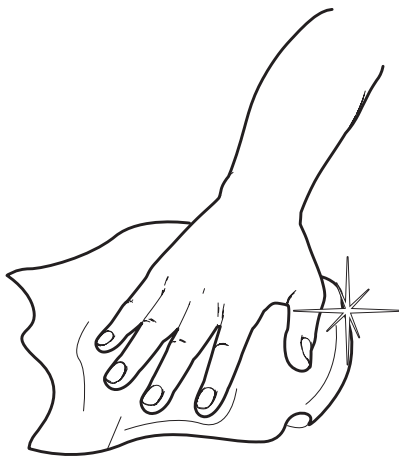
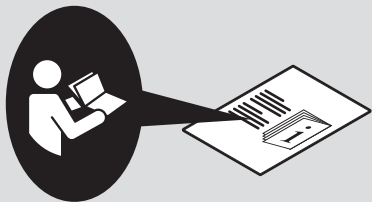

**Artemide®**

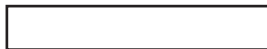

**Artemide**

via Bergamo, 18  
20010 Pregnana M.se (MI)  
ITALIA

tel. +39 02 935 181  
fax +39 02 935 90 254  
fax +39 02 935 90 496

[www.artemide.com](http://www.artemide.com)

VAT IT00846890150

cod. Y513000998